

<b>TEST REPORT</b> <b>DIN V VDE V 0126-1-1:2013.08</b> <b>Automatic disconnecting device</b>	
<b>Report Reference No.</b> .....	190411093GZU-003
<b>Date of issue</b> .....	13 Mar 2020
<b>Total number of pages</b> .....	27 pages
<b>Testing Laboratory</b> .....	Intertek Testing Services Shenzhen Ltd. Guangzhou Branch
<b>Address</b> .....	Block E, No.7-2 Guang Dong Software Science Park, Caipin Road, Guangzhou Science City, GETDD, Guangzhou, China
<b>Testing location/ address</b> .....	Same as above
<b>Tested by (name + signature)</b> .....	Sunny Lin <i>Sunny Lin</i> Engineer
<b>Approved by (+ signature)</b> .....	Jason Fu <i>Jason Fu</i> Technical Team Leader
<b>Applicant's name</b> .....	Shenzhen SOFAR SOLAR Co., Ltd.
<b>Address</b> .....	401, Building 4, AnTongDa Industrial Park, District 68, XingDong Community, XinAn Street, BaoAn District, Shenzhen, China
<b>Test specification:</b>	
<b>Standard</b> .....	DIN V VDE V 0126-1-1:2013.08
<b>Test procedure</b> .....	Type approval
<b>Non-standard test method</b> .....	N/A
<b>Test Report Form No.</b> .....	VDE0126-1-1b
<b>Test Report Form(s) Originator</b> .....	Intertek
<b>Master TRF</b> .....	Dated 2013-09
This publication may be reproduced in whole or in part for non-commercial purposes as long as Intertek is acknowledged as copyright owner and source of the material. Intertek takes no responsibility for and will not assume liability for damages resulting from the reader's interpretation of the reproduced material due to its placement and context.	
<b>Test item description</b> .....	Solar Grid-tied Inverter
<b>Trade Mark</b> .....	SOFAR SOLAR
<b>Manufacturer</b> .....	Same as Applicant
<b>Model/Type reference</b> .....	SOFAR 1000TL-G2, SOFAR 12000TL-G2, SOFAR 15000TL-G2

Rating.....:	Model	SOFAR 10000TL-G2	SOFAR 12000TL-G2	SOFAR 15000TL-G2
	Max.PV voltage	1000 d.c.V		
	PV MPPT voltage range	160-960 d.c.V		
	Max.input current	21 /11 d.c.A		
	PV Isc	30/15 d.c.A		
	Max.output power	10000W	12000W	15000W
	Max.apparent power	11000VA	13200VA	16500VA
	Nominal output voltage	3/N/PE, 230 /400 a.c.V		
	Max.output current	3x16.5 a.c.A	3x20.0 a.c.A	3x24.0 a.c.A
	Nominal output Frequency	50 Hz		
	Power factor range	0.8Leading – 0.8 lagging		
	Inverter technology	Non-isolated		
	Safety level	Class I		
	Ingress Protection	IP 65		
	Operation Ambient Temperature	-25°C - +60°C		
Software Version	V1.30			

<b>Summary of testing:</b>	
<b>Tests performed (name of test and test clause):</b> All applicable test items.	<b>Testing location:</b> Intertek Testing Services Shenzhen Ltd. Guangzhou Branch

**Copy of marking plate(representative):**  
The artwork below may be only a draft. The use of certification marks on a product must be authorized by the respective NCBs that own these marks.

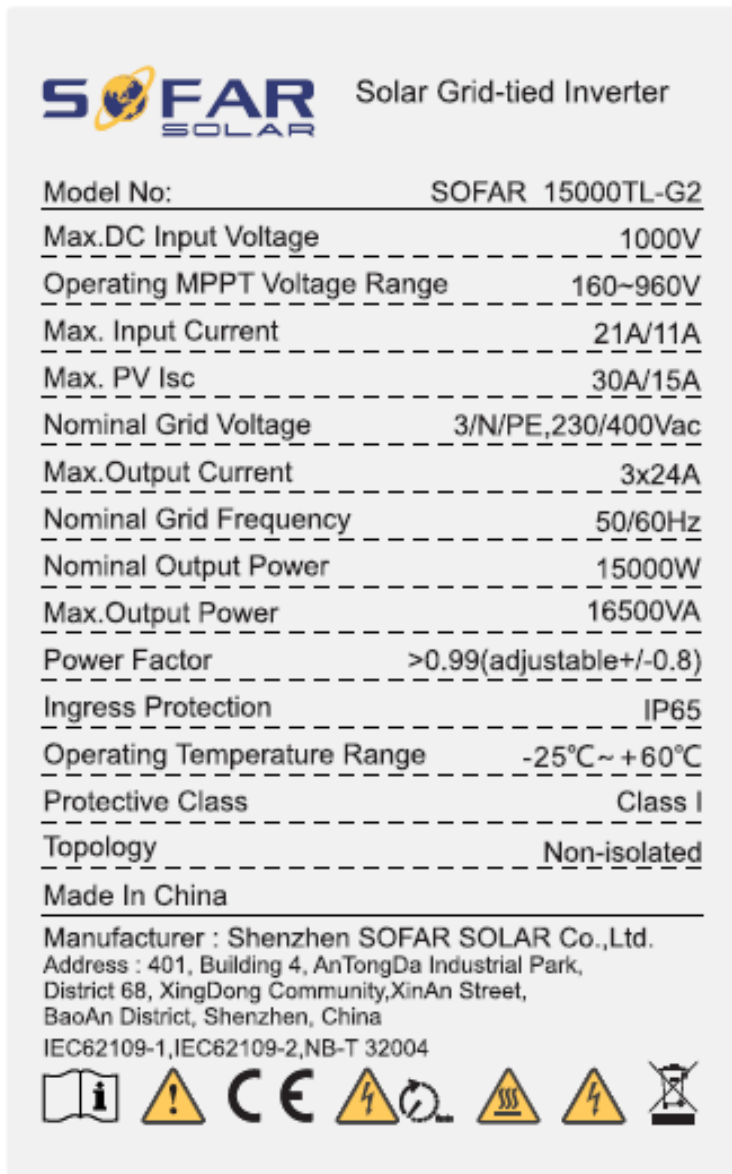

**Note:**

1. The above markings are the minimum requirements required by the safety standard. For the final production samples, the additional markings which do not give rise to misunderstanding may be added.
2. Label is attached on the side surface of enclosure and visible after installation.
3. Other labels are identical to above, except the model name and ratings

<b>Test item particulars</b> .....:	
Temperature range .....	-25°C ~ 60 °C
Overvoltage category .....	<input type="checkbox"/> OVC I <input checked="" type="checkbox"/> OVC II (for PV input) <input checked="" type="checkbox"/> OVC III (for main) <input type="checkbox"/> OVC IV
IP protection class .....	IP65
<b>Possible test case verdicts:</b>	
- test case does not apply to the test object.....	: N/A
- test object does meet the requirement .....	: P (Pass)
- test object does not meet the requirement .....	: F (Fail)
<b>Testing</b> .....:	
Date of receipt of test item.....	: 02 Jan 2020
Date (s) of performance of tests.....	: 02 Jan 2020 to 10 Mar 2020
<b>General remarks:</b>	
<p>The test results presented in this report relate only to the object tested.  This report shall not be reproduced, except in full, without the written approval of the Issuing testing laboratory.  "(see Enclosure #)" refers to additional information appended to the report.  "(see appended table)" refers to a table appended to the report.</p> <p>Throughout this report a point is used as the decimal separator.  Clause numbers in parentheses derive from VDE-AR-N 4105:2011-08.</p> <p>When determining the test conclusion, the Measurement Uncertainty of test has been considered.</p> <p>This report is for the exclusive use of Intertek's Client and is provided pursuant to the agreement between Intertek and its Client. Intertek's responsibility and liability are limited to the terms and conditions of the agreement. Intertek assumes no liability to any party, other than to the Client in accordance with the agreement, for any loss, expense or damage occasioned by the use of this report. Only the Client is authorized to permit copying or distribution of this report and then only in its entirety. Any use of the Intertek name or one of its marks for the sale or advertisement of the tested material, product or service must first be approved in writing by Intertek. The observations and test results in this report are relevant only to the sample tested. This report by itself does not imply that the material, product, or service is or has ever been under an Intertek certification program.</p> <p>The test report only allows to be revised only within the report defined retention period unless standard or regulation was withdrawn or invalid.</p>	

**General product information:**

The unit is a three-phases non-isolated PV Grid-tied inverter, it can convert the high PV voltage to Grid voltage and feed into Grid network.

The unit is providing EMI filtering at the PV side and AC side. It does provide basic insulation from PV side to Grid.

The unit has two controllers. The master controller A monitor the invert statue; measure the PV voltage and current, bus voltage, AC voltage, current, GFCI and frequency, also communicate with the slave controller B

The slave controller B monitor AC voltage, current, frequency, GFCI and communicate with the master controller A

The relays are designed to redundant structure that controlled by separately.

The master controller and slave controller are used together to control relay open or close, if the single fault on one controller, the other controller can be capable to open the relay, so that still providing safety means.

The topology diagram as following:

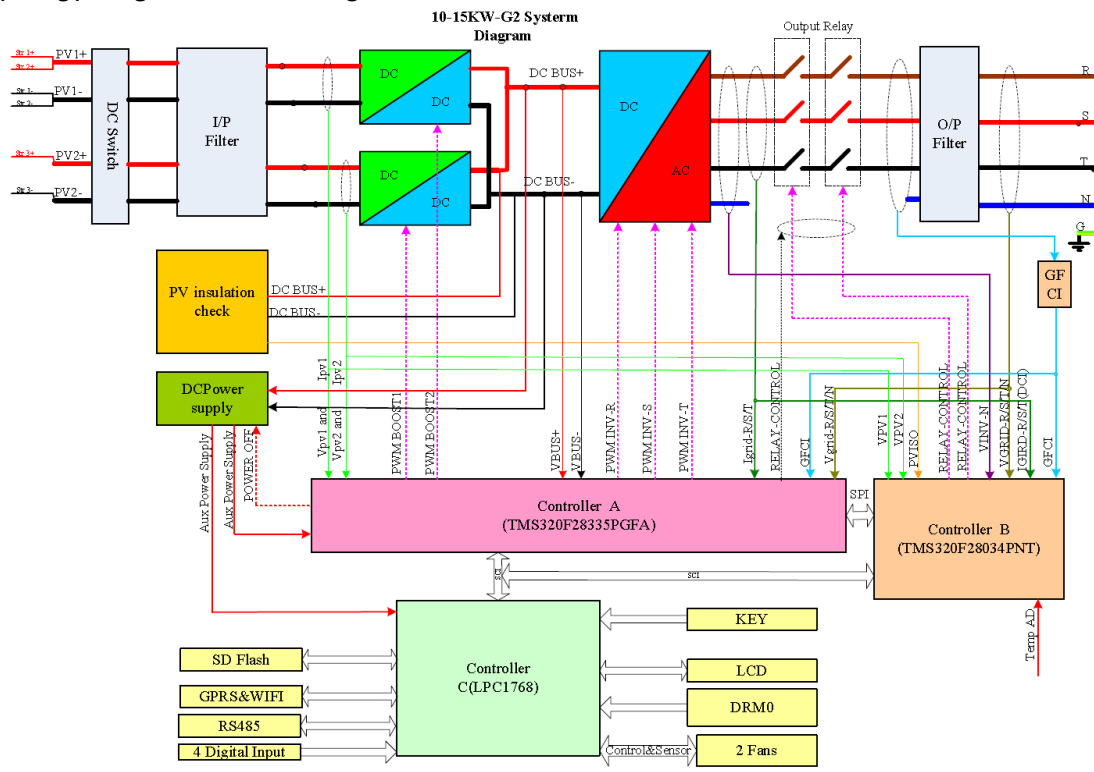

**Models differences:**

The model SOFAR 10000TL-G2, SOFAR 12000TL-G2 and SOFAR 15000TL-G2 are completely identical, except output power derating in software.

The only differences on hardware between the models SOFAR 10000TL-G2, SOFAR 12000TL-G2 and SOFAR 15000TL-G2 are below:

The main output inductor is NPS226060\*2+NPF226060\*2, 2.0Φ\*2P /37Ts L=756μH for model SOFAR 15000TL-G2 while it's NPS226060\*2+NPF226060\*1, 2.0Φ\*2P\*42Ts L=0.73mH for model SOFAR 10000TL-G2, SOFAR 12000TL-G2

**Factory information:**

Dongguan SOFAR SOLAR Co., Ltd

1F-6F, Building E, No.1 JinQi Road, Bihu Industrial Park, Wulian Village, Fenggang Town, Dongguan City, China

DIN V VDE V 0126-1-1:2013.08			
Clause	Requirement - Test	Result - Remark	Verdict
<b>4</b>	<b>REQUIREMENTS</b>		P
4.0	<b>General</b>		P
	<p>These requirements apply to integrated or separate (independent) disconnecting devices unless otherwise noted.</p> <p>The disconnection device has to cut off the power generating system on the ac side from the grid by two switches in series when:</p> <ul style="list-style-type: none"> <li>— the voltage and/or the frequency of the grid is deviating,</li> <li>— direct current (DC) is fed into the Grid.</li> <li>— unintentional islanding operation occurs,</li> <li>— intentional islanding operation using grid backup systems (emergency supplies).</li> </ul>		P
<b>4.1</b>	<b>Functional safety</b>		P
	The safety must be assured under all operating conditions complying with the defined functions 4.3 to 4.6 and – if applicable – 4.8 of the disconnection device. The disconnection device can be an independent unit or an integrated part of the power generating unit and must switch off in case of a fault and indicate the fault status	Considered, see Annex. The single fault safe system was reviewed. The theoretical investigation was verified by error simulation.	P
<b>4.1.1</b>	<b>Single fault tolerance</b>		P
	The disconnection device must comply with the single fault tolerance requirements of VDE-AR-N 4105:2011-08, A.6	Considered, functional explanation and table 6.1 below.	P
<b>4.1.2</b>	<b>Interface Switch</b>		P
	The interface switch must, in case it is integrated into a PV-inverter, comply with the requirements of DIN EN 62109-2(VDE 0126-14-2):2012-04, 4.4.4.15.2 and in all other cases with the requirements according to VDE-AR-N 4105:2011-08, 6.4.	Disconnection takes place redundant through two relays and the IGBT-full bridge in series. The relays and the IGBT-full bridge are able to switch the full current.	P
<b>(6.4.1)</b>	<b>General</b>		P
	<p>For the connection of the power generation system to the network operator's low-voltage network or to the remaining customer system, it is necessary to use an interface switch. It consists of two electric switching devices connected in series and shall thus be constructed redundantly. The interface switch is controlled by the NS protection and activates automatically if at least one protective function responds.</p> <p>The breaking devices of the interface switch shall be designed to be short-circuit proof and shall be</p>		P

DIN V VDE V 0126-1-1:2013.08			
Clause	Requirement - Test	Result - Remark	Verdict
	<p>releasable without delay and with due regard to the protective devices required by clause 6.5. The breaking capacity of the two breaking devices of the interface switch shall be dimensioned at least in accordance with the responding range of the upstream safety fuse or the maximum short-circuit current contribution of the power generation system.</p> <p>Switches with at least breaking capacity shall be use for both breaking devices of the interface switch. In addition to that, all-pole disconnection shall be ensured.</p>		
<b>(6.4.2)</b>	<b>Central interface switch</b>		N/A
	<p>The two break devices of the central interface switch shall be executed as galvanic break devices.</p> <p>The two break devices of the interface switch shall be installed directly at the central meter panel in the circuit distributor of the power generation system.</p>		N/A
<b>(6.4.3)</b>	<b>Integrated interface switch</b>		P
	<p>Construction of the interface switch shall be carried out taking into consideration the single-fault tolerance.</p> <p>An interface switch ensures a single-fault tolerant all-phase galvanic breaking.</p> <p>For power generation systems with inverters, the interface switch shall be provided on the inverter's network side. A short circuit in the inverter shall not impair the switching function of the interface switch.</p>		P
<b>4.2</b>	<b>Connection conditions</b>		P
	<p>The connection, the reconnection after a grid-fault and the reconnection after short interruption shall be carried out according to VDE-AR-N 4105:2011-08, 8.3.1</p>		P
<b>(8.3.1)</b>	<b>General</b>		P
	<p>A power generation system shall be connected to the network operator's network only if a suitable device determines that both the mains voltage and the mains frequency are within the tolerance range of 85 % Un to 110 % Un or 47.5 Hz to 50.05 Hz, respectively, for a period of at least 60 seconds.</p> <p>If decoupling protection devices are tripped because of a short interruption, then the power generation system is permitted to already reconnect as soon as the mains voltage and mains frequency have uninterruptedly remained within the tolerance ranges given above for a period of 5 seconds. Short time interruptions are characterised by the NS protection settings of the mains frequency and/ or network voltage being exceeded or undershot for a maximum period of 3 seconds.</p> <p>The power generation system being reconnected to the</p>	<p>Tested with a variable AC-Power supply at the output. Inverter disconnects within the limits, see table 6.2 below.</p>	P

DIN V VDE V 0126-1-1:2013.08			
Clause	Requirement - Test	Result - Remark	Verdict
	network operator's network at the tripping of the decoupling protection device, the active power of controllable power generation systems supplied to the network operator's network shall not exceed the gradient of 10 % of the active power per minute.		
<b>4.3</b>	<b>Monitoring the voltage</b>		P
<b>4.3.1</b>	<b>voltage drop <math>U &lt;</math></b>		P
	The disconnection because of a voltage drop shall be carried out according to VDE-AR-N 4105:2011-08, 6.5.1 and 6.5.2	See appended table below.	P
<b>4.3.2</b>	<b>rise-in-voltage <math>U &gt;&gt;</math></b>		P
	The disconnection because of a rise-in-voltage shall be carried out according to VDE-AR-N 4105:2011-08, 6.5.1 and 6.5.2	See appended table below.	P
<b>4.3.3</b>	<b>slow rise-in-voltage <math>U &gt;</math></b>		P
	The disconnection because of a slow rise-in-voltage (10-minute-average) shall be carried out according to VDE-AR-N 4105:2011-08, 6.5.1 and 6.5.2	See appended table below.	P
<b>4.4</b>	<b>Monitoring the frequency</b>		P
	The disconnection because of a frequency decrease or a frequency increase shall be carried out according to VDE-AR-N 4105:2011-08, 6.5.1 and 6.5.2	See appended table below.	P
<b>(6.5.1)</b>	<b>General</b>		P
	<p>The purpose of the NS protection is to disconnect the power generation system from the net in the event of inadmissible voltage and frequency values. This is intended to prevent an unintentional feed-in of the power generation system into a power-supply unit separated from the remaining distribution network as well as the feed-in of faults within this network.</p> <p>The system operator shall himself take precautions to prevent damages to his systems and installations as might be caused by switching actions, voltage fluctuations and automatic reclosings in the network connected upstream or other process in the network of the network operator.</p> <p>The following functions of the decoupling protection shall be implemented:</p> <ul style="list-style-type: none"> <li>- Voltage drop protection <math>U &lt;</math>;</li> <li>- Rise-in-voltage protection <math>U &gt;</math>;</li> <li>- Rise-in-voltage protection <math>U &gt;&gt;</math>;</li> <li>- Frequency decrease protection <math>f &lt;</math>;</li> <li>- Frequency increase protection <math>f &gt;</math>;</li> <li>- Islanding detection.</li> </ul>		P



DIN V VDE V 0126-1-1:2013.08			
Clause	Requirement - Test	Result - Remark	Verdict
	The setting values of the protective functions and the last five dated failure reports shall be readable at the NS protection. Interruptions of supply with durations of 3 s or longer shall not lead to loss of any of the failure reports. Read-out shall be possible at the central NS protection irrespective of the operational state of the power generation system and without any additional aids. For integrated NS protection read-out may be carried out using a data interface.		
<b>(6.5.2)</b>	<b>Protective functions</b>		P
	The protective functions of the NS protection shall be designed so that the disconnection time (the sum of the proper times of NS protection and interface switch plus a delay for the protection relay, which may or may not be adjustable) does not exceed 200 ms.		P
<b>4.5</b>	<b>Monitoring the dc current</b>		P
	A feed in of d.c current into the low-voltage grid due to defective equipment must lead to a switch off within 0.2 seconds. For this purpose the fault itself or a measurement of the dc component of the current exceeding 1 A can be used as disconnection criteria.	See appended table below.	P
<b>4.6</b>	<b>Detection of islanding operation</b>		P
	The disconnection because of a detection of unintended islanding operation shall be carried out according to VDE-AR-N 4105:2011-08, 6.5.1 and 6.5.3	See appended table below.	P
<b>(6.5.3)</b>	<b>Islanding detection</b>		P
	The islanding detection is implemented in the central NS protection or in the integrated NS protection of the power generation unit. If an islanding detection system acting on the integrated interface switch is integrated in all power generation units of a power generation system, then it is permitted to omit the islanding detection in the central NS protection regardless of the system power.  Detection of an isolated network and disconnection of the power generation system by means of the interface switch shall be completed within 5 seconds.	See appended table below.	P
<b>4.7</b>	<b>Markings</b>		P
	A generating system equipped with an automatic disconnecting device shall be marked with the information "VDE 0126-1-1" which is visible from the outside. This can be done by  — the marking plate or  — showing it on a display of the disconnection device or		P

DIN V VDE V 0126-1-1:2013.08			
Clause	Requirement - Test	Result - Remark	Verdict
	— a separate marking		
<b>4.8</b>	<b>Requirements for disconnection devices integrated into PV-inverters</b>		P
	The requirements of the DIN EN 62109-2 (VDE 0126-14-2):2012-04, 4.8 regarding the residual current detection and the insulation detection of the PV-generator shall be complied with.		P
<b>5</b>	<b>General Requirements</b>		P
	Limits according to DIN EN 61000-6-3 (VDE 0839-6-3) regarding radio interferences must be complied with. For disturbance-free operation disturbance limits according to DIN EN 61000-6-2 (VDE 0839-6-2) shall be complied with.		P
<b>6</b>	<b>TYPE TESTING</b>		<b>P</b>
<b>6.0</b>	<b>General</b>		P
	The following tests are valid for integrated and separated disconnecting devices unless otherwise noted. A separate disconnection device must be tested together with a suitable supply. It has to be ensured that the turn-off signal is caused by the disconnection device and not by the supply.	See following of test report	P
<b>6.1</b>	<b>Functional safety</b>		P
	The testing of the single fault tolerance and the error detection with following disconnection according to 4.1 is carried out according to DIN VDE V 0124-100 (VDE V 0124-100):2012-07, 5.4.5.2.		P
<b>6.2</b>	<b>Connection conditions</b>		P
	The testing of the connection and the reconnection is carried out according to DIN VDE V 0124-100 (VDE V 0124-100):2012-07, 5.5.1 and 5.5.2.		P
<b>6.3</b>	<b>Monitoring the voltage</b>		P
	The testing of the voltage monitoring is carried out according to DIN VDE V 0124-100 (VDE V 0124-100):2012-07, 5.4.5.3.		P
<b>6.4</b>	<b>Monitoring the frequency</b>		P
	The testing of the frequency monitoring is carried out according to DIN VDE V 0124-100 (VDE V 0124-100):2012-07, 5.4.5.4.		P
<b>6.5</b>	<b>Monitoring the dc current</b>		P

DIN V VDE V 0126-1-1:2013.08			
Clause	Requirement - Test	Result - Remark	Verdict
	<p>The testing of the disconnection due to feed in of direct current is carried out either by a) or b):</p> <p>a) The measuring device at the switching point (e.g. current transformer or resistance) is fed with direct current of 1 A. The cut-off must be carried out within 0.2 seconds.</p> <p>b) By means of a fault simulation it is measured if a defective system operation with a d.c. fault current of more than 1 A leads to cut-off within 0.2 seconds.</p>		P
<b>6.6</b>	<b>Detection of islanding operation</b>		P
	The testing of the disconnection due to unintended islanding operation is carried out according to DIN VDE V 0124-100 (VDE V 0124-100):2012-07, 5.4.6.		P
<b>7</b>	<b>Routine Test</b>		<b>P</b>
	The manufacturer has to carry out routine tests regarding all safety relevant functions before delivering an automatic disconnection device.		P
<b>8</b>	<b>Construction Specification</b>		<b>P</b>
	Initial tests and re-examination in addition to the routine tests may be omitted. If the disconnection device is a separate unit it must not be used in a TN-C power system. In this case a TN-C-S power system must be created.		P

<b>6.1</b> <b>(5.4.5.1 &amp; 5.4.5.2)</b>	<b>TABLE: General requirements</b>	<b>P</b>
--	------------------------------------	----------

Design of functional safety:

The unit has two controllers. The master controller A monitor the invert statue; measure the PV voltage and current, bus voltage, AC voltage, current, GFCI and frequency, also communicate with the slave controller B

The slave controller B monitor AC voltage, current, frequency, GFCI and communicate with the master controller A

The relays are designed to redundant structure that controlled by separately.

The master controller and slave controller are used together to control relay open or close, if the single fault on one controller, the other controller can be capable to open the relay, so that still providing safety means.

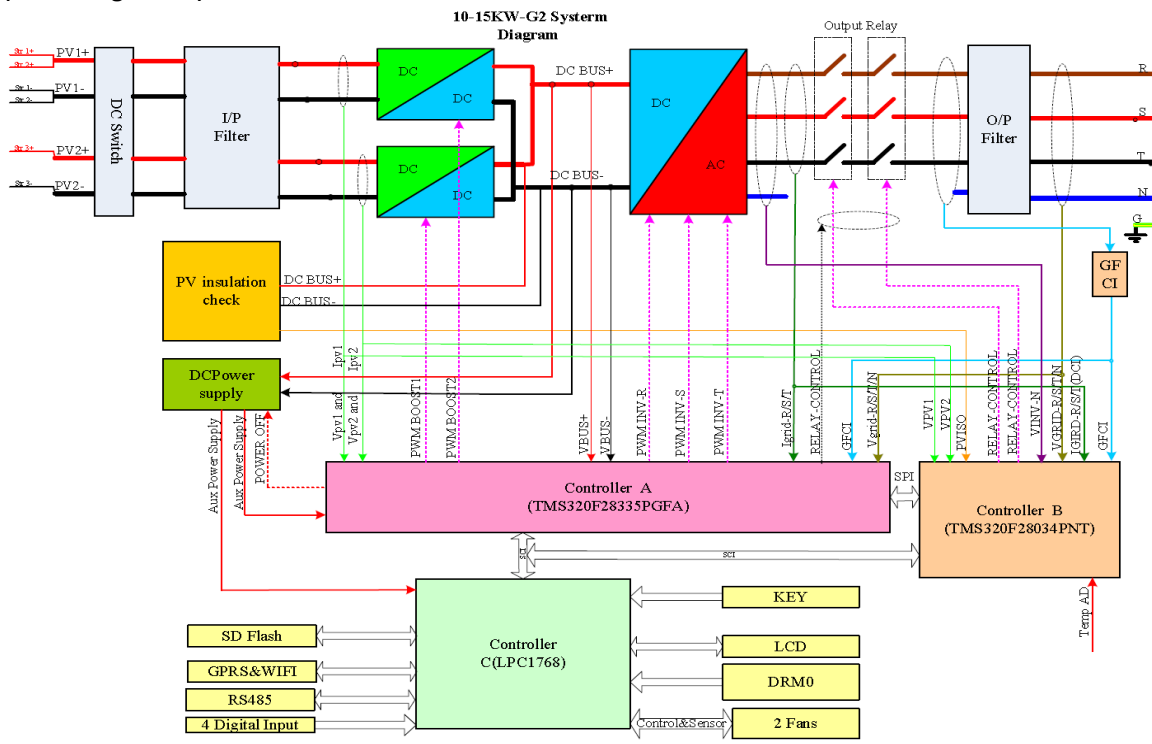

6.1 (6.5.1)			TABLE: General requirements				
String	1	$U_{DC} = U_n$	850Vdc	$U_{ac} = U_n$	230 Vac	$P = (W)$	15000
Component No.	Fault	Observation					
R150	S-C	LCD displays 'ID27' for three times and then displays 'ID69'. Recoverable. No hazard, no damaged.					
R27	S-C	LCD displays 'ID24' for three times and then displays 'ID67'. Recoverable. No hazard, no damaged.					
R26	O-C	LCD displays 'ID02'. Recoverable. No hazard, no damaged.					
Relay defect RL1 Pin3-4	S-C before start up	The EUT cannot start, LCD displays "ID55". Recoverable. No hazard, no damaged.					

Relay defect RL3 Pin3-4	S-C before start up	The EUT cannot start, LCD displays "ID55". Recoverable. No hazard, no damaged.
Relay defect RL5 Pin3-4	S-C before start up	The EUT cannot start, LCD displays "ID55". Recoverable. No hazard, no damaged.
Q25 pin1-2	S-C	LCD displays 'ID52'. Recoverable. No hazard, no damaged.
RC609	S-C	PCE Shutdown, LCD displays 'ID53'. Recoverable. No hazard, no damaged.
R44	O-C	LCD displays 'ID27'. Recoverable. No hazard, no damaged.
CC243	S-C	PCE Shutdown, LCD displays 'ID53'. Recoverable. No hazard, no damaged.
CC222	S-C	LCD displays 'ID55'. Recoverable. No hazard, no damaged.
CC132	S-C	PCE Shutdown, LCD displays 'ID49'. Recoverable. No hazard, no damaged.
RC459	S-C	PCE Shutdown, LCD displays 'ID59'. Recoverable. No hazard, no damaged.
RL6	S-C	PCE Shutdown, LCD displays 'ID55'. Recoverable. No hazard, no damaged.

Supplementary information:

S-C: Short circuit, O-C: Open circuit

During the test:

Fire do not propagates beyond the EUT;

Equipment do not emit molten metal;

Enclosures do not deform to cause non-compliance with the standard.

Pass the dielectric test.

6.2 (5.5.1)	Connection conditions		P
DC input:	AC output:	Rated Output Power	
700Vdc	230Vac; 50Hz	15000W	
Measure Item	Reconnection?		Reconnection Time (>60s)
$f_{ist} = 47,45\text{Hz}$	<input type="checkbox"/> Yes	<input checked="" type="checkbox"/> No	Cannot reconnection
$f_{ist} \geq 47,55\text{Hz}$	<input checked="" type="checkbox"/> Yes	<input type="checkbox"/> No	67.0s
$f_{ist} > 50,1\text{Hz}$	<input type="checkbox"/> Yes	<input checked="" type="checkbox"/> No	Cannot reconnection
$f_{ist} \leq 50,1\text{Hz}$	<input checked="" type="checkbox"/> Yes	<input type="checkbox"/> No	66.5s
$U_{ist} < 85\% U_n$	<input type="checkbox"/> Yes	<input checked="" type="checkbox"/> No	Cannot reconnection
$U_{ist} \geq 85\% U_n$	<input checked="" type="checkbox"/> Yes	<input type="checkbox"/> No	67.0s
$U_{ist} > 110\% U_n$	<input type="checkbox"/> Yes	<input checked="" type="checkbox"/> No	Cannot reconnection
$U_{ist} \leq 110\% U_n$	<input checked="" type="checkbox"/> Yes	<input type="checkbox"/> No	67.0s

Graph of the gradual power supply and reconnection: for 47.55Hz

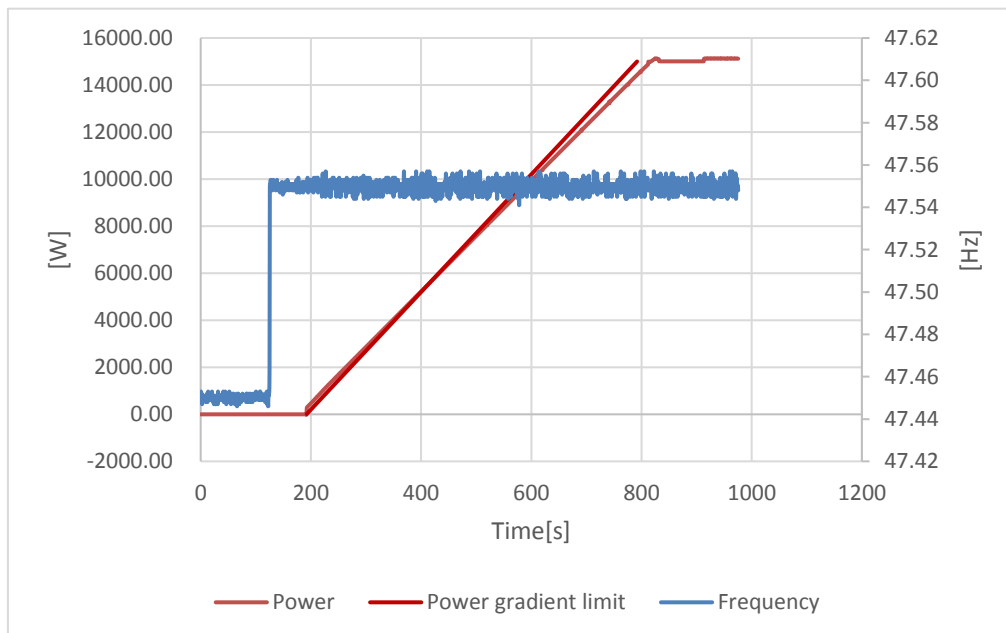

Graph of the gradual power supply and reconnection: for 50.1Hz

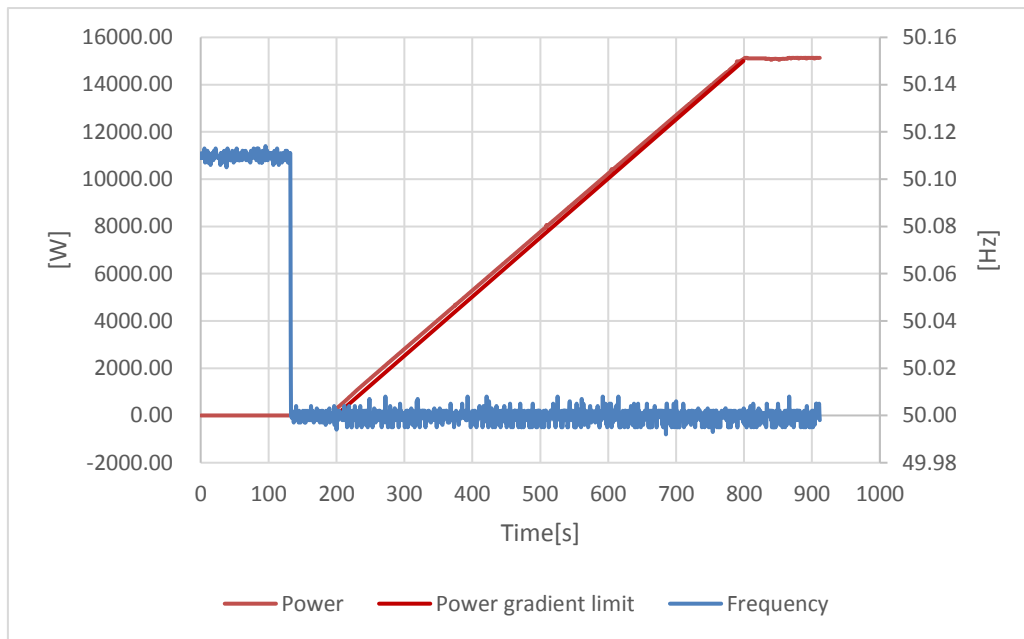

Graph of the gradual power supply and reconnection: for 85%Un

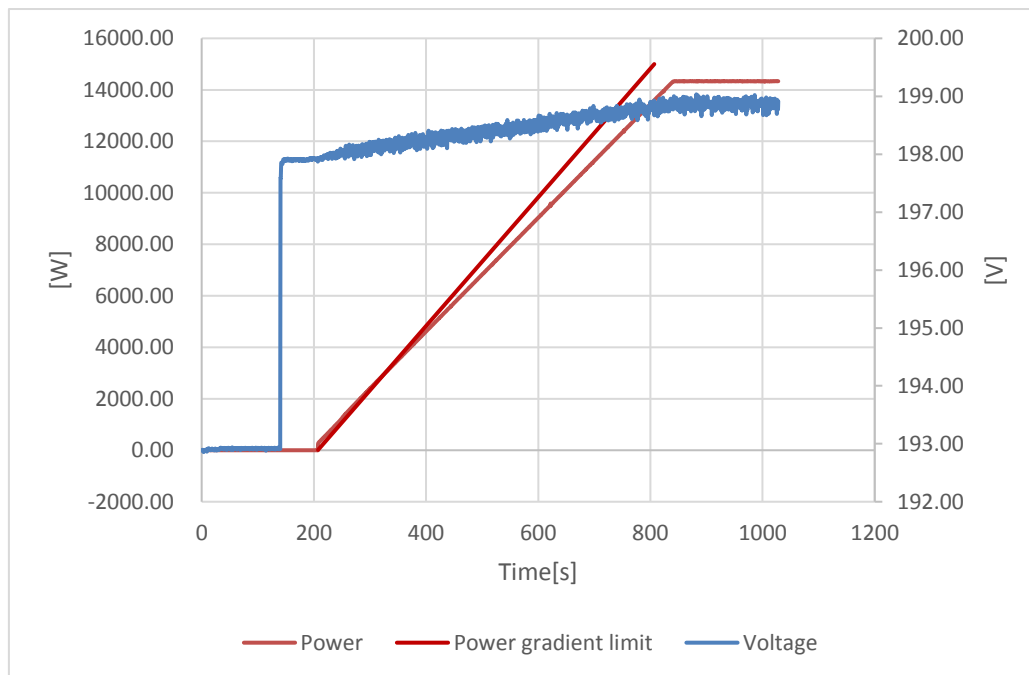

Graph of the gradual power supply and reconnection: for 110%Un

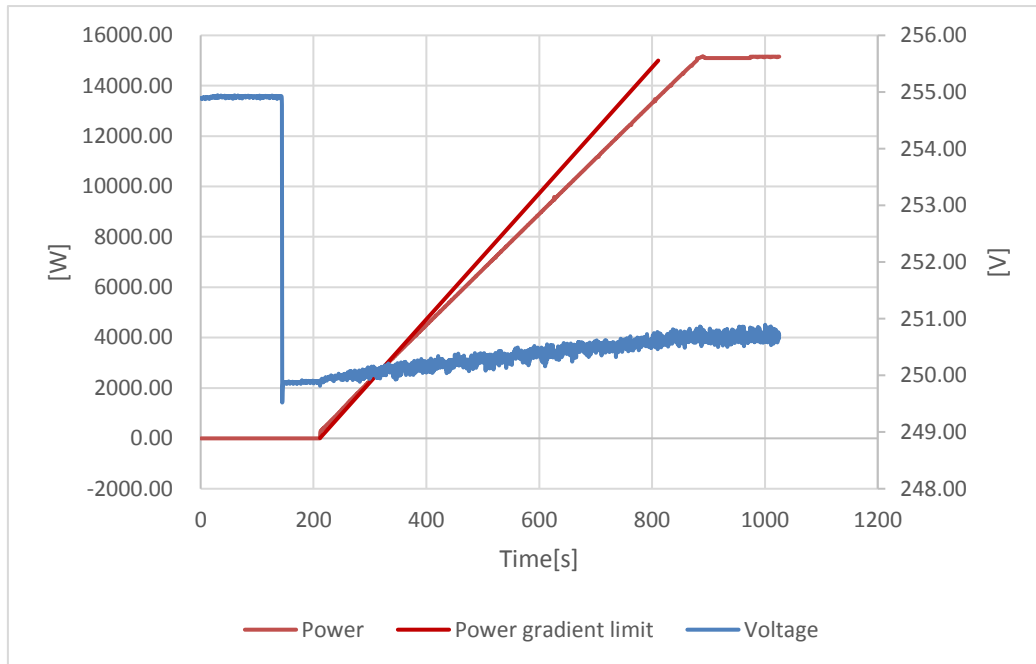



6.2 (5.5.2)	Short-time Interruption									P
	1			2			3			
	U <sub>n</sub> (V)	Repeated Time (s)	Gradient (W/min)	U <sub>n</sub> (V)	Repeated Time (s)	Gradient (W/min)	U <sub>n</sub> (V)	Repeated Time (s)	Gradient (W/min)	
After 2s of 77% U <sub>n</sub>	230	66.5	1487.09	230	66.5	1486.94	230	67.0	1486.97	
After 4s of 77% U <sub>n</sub>	230	67.0	1487.21	230	66.5	1486.15	230	66.5	1485.95	

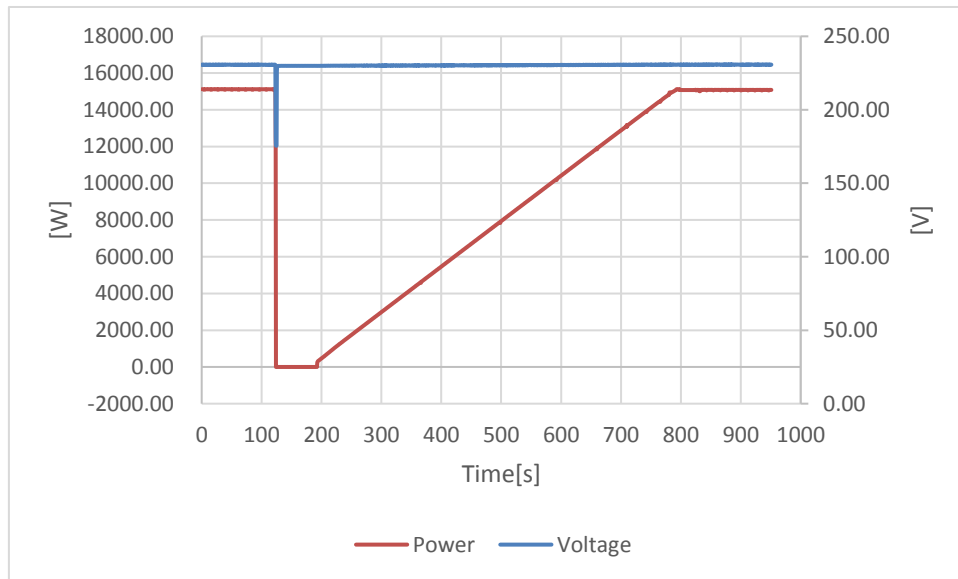

After 2s of 77% U<sub>n</sub>

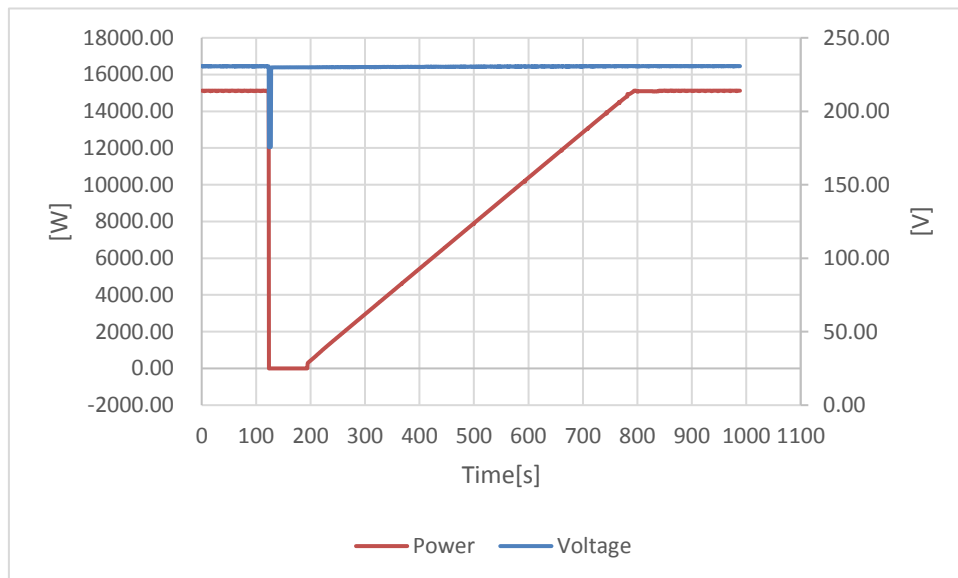

After 4s of 77% U<sub>n</sub>

6.3 (5.4.5.3)	Monitoring the voltage (Results of Voltage monitoring)					P
Rated Voltage (Un)	230Vac		Rated Frequency		50Hz	
	1		2		3	
Overvoltage protection						
L1-N	264.14	154.0ms	264.46	165.0ms	264.27	163.0ms
L2-N	264.61	160.0ms	265.18	166.0ms	265.30	151.0ms
L3-N	265.65	148.0ms	265.44	167.0ms	264.83	164.0ms
L1L2L3-N	264.46	160.0ms	264.47	166.0ms	264.49	162.0ms
Undervoltage protection						
L1-N	183.40	167.0ms	183.53	168.0ms	183.45	160.0ms
L2-N	184.50	157.0ms	184.40	167.0ms	184.36	166.0ms
L3-N	183.63	157.0ms	183.72	173.0ms	183.78	155.0ms
L1L2L3-N	184.79	170.0ms	183.79	168.0ms	184.84	169.0ms

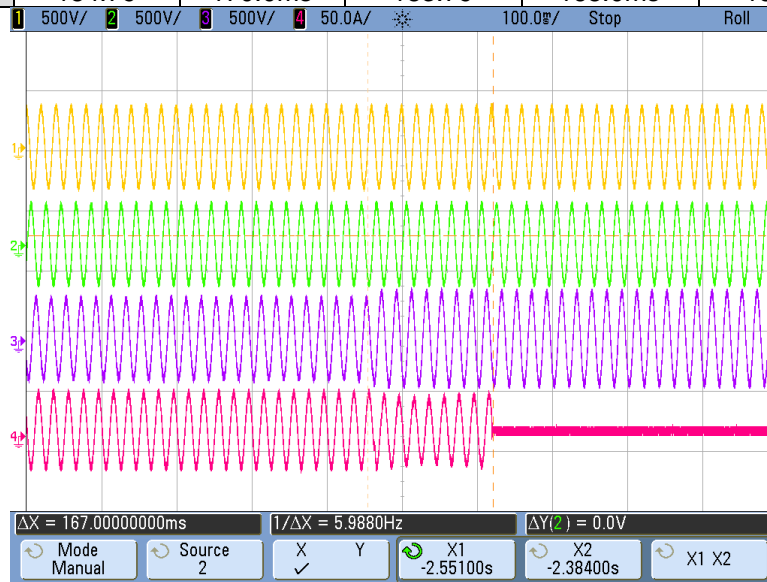

Overvoltage Protection

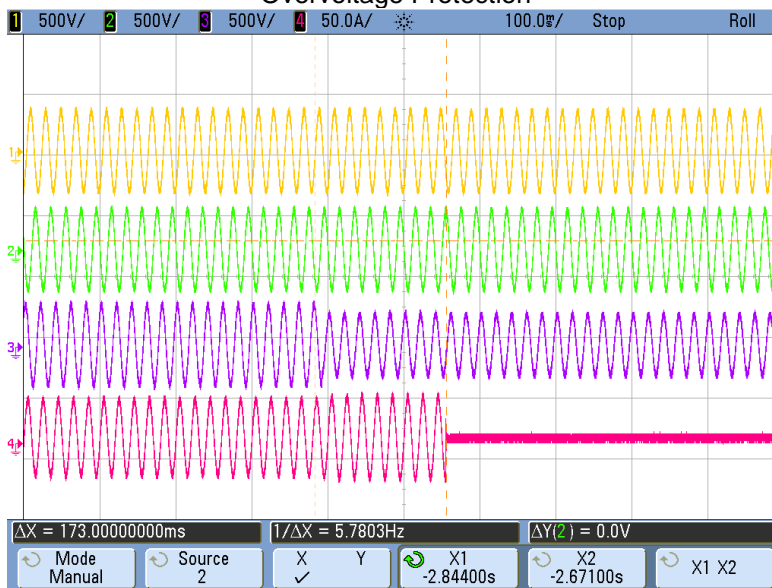

Undervoltage Protection

CH1,CH2,CH3 denotes Voltage of output, CH4 denotes current of output

6.3 (5.4.5.3)	Monitoring the voltage (Results of the Protection of the Increase in Voltage as 10-min moving average)			P
	Output Voltage (V)	Switch		
		On/Off state Finally		Time until Switch off (s)
100% Un	230.0	<input checked="" type="checkbox"/> On	<input type="checkbox"/> Off	Work normally
112% Un	257.6	<input type="checkbox"/> On	<input checked="" type="checkbox"/> Off	511.0s
100% Un	230.0	<input checked="" type="checkbox"/> On	<input type="checkbox"/> Off	Work normally
108% Un	248.4	<input checked="" type="checkbox"/> On	<input type="checkbox"/> Off	Work normally
106% Un	243.8	<input checked="" type="checkbox"/> On	<input type="checkbox"/> Off	Work normally
114% Un	262.2	<input type="checkbox"/> On	<input checked="" type="checkbox"/> Off	298.0s

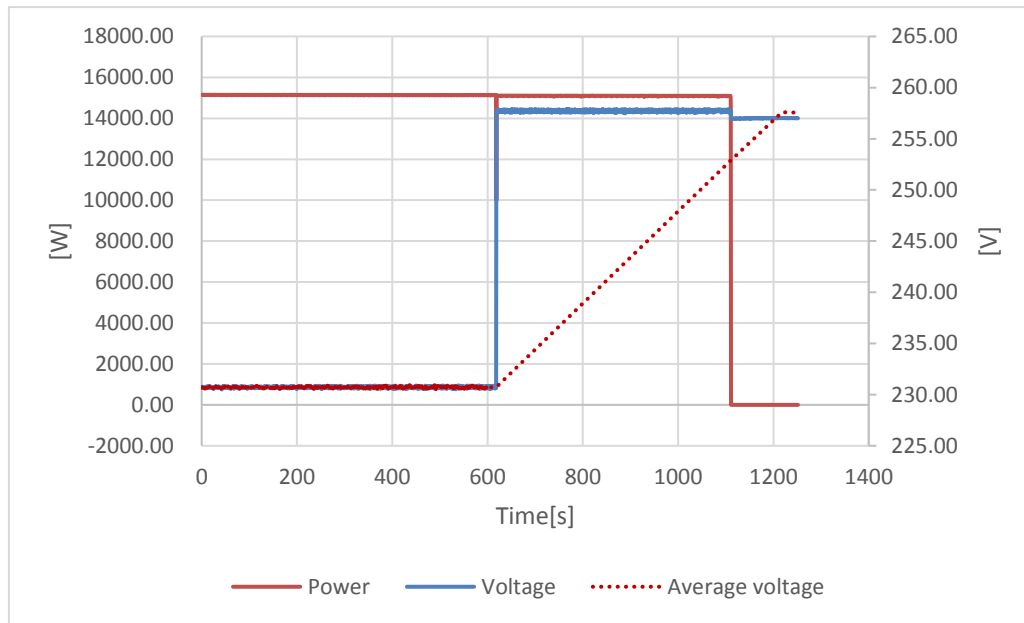

Un to 112% Un

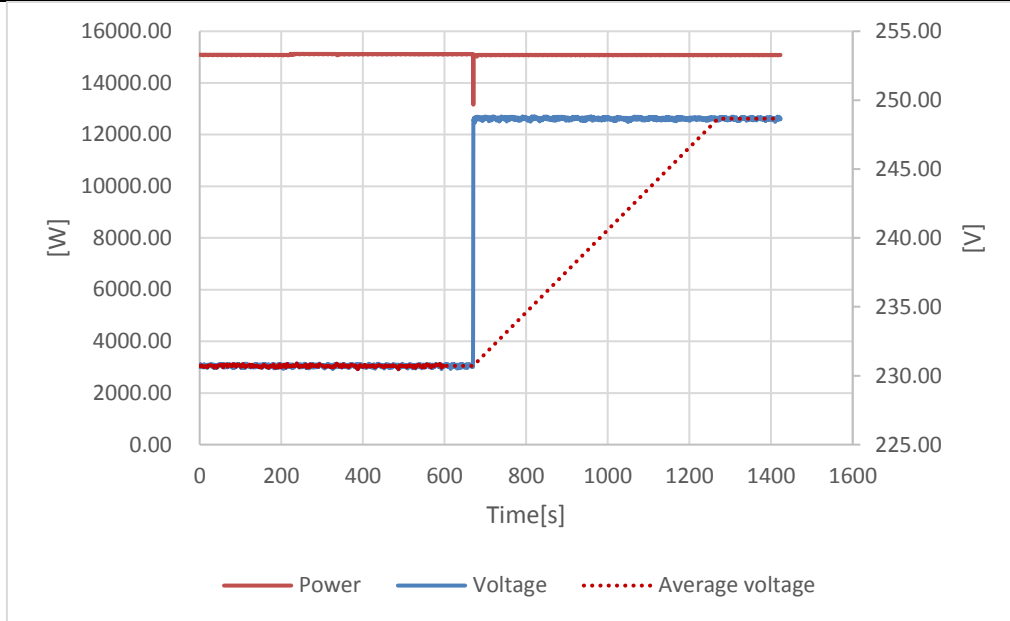

Un to 108% Un

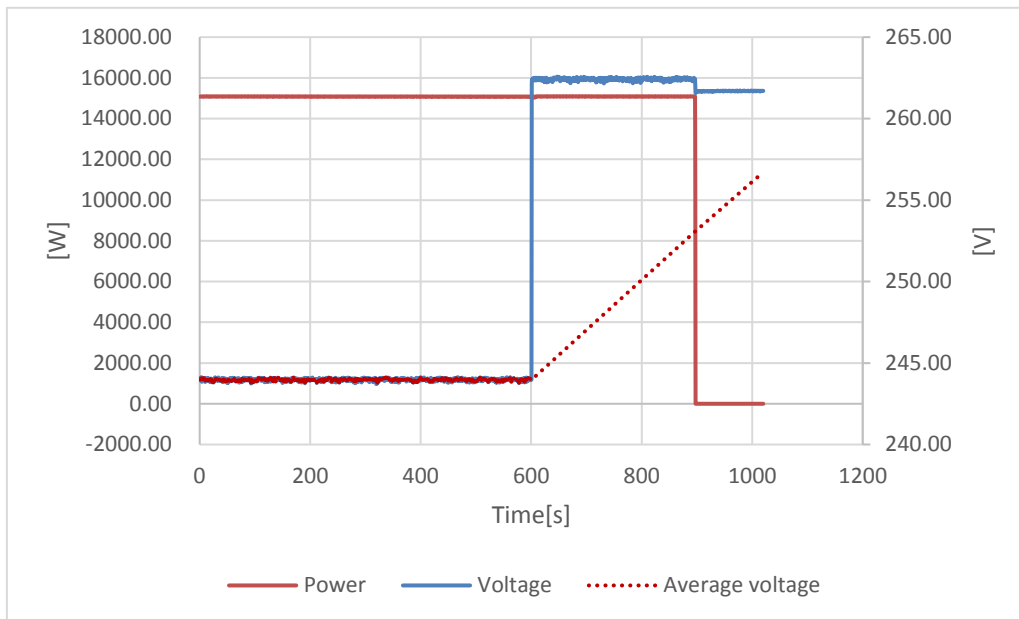

106Un to 114% Un

6.4 (5.4.5.4)	Monitoring the frequency						P
	1		2		3		
	f (Hz)	Trip time (ms)	f (Hz)	Trip time (ms)	f (Hz)	Trip time (ms)	
Frequency decrease	47.50	158.0	47.50	160.0	47.50	161.0	
Frequency increase	51.51	175.0	51.51	172.0	51.51	164.0	



Frequency decrease

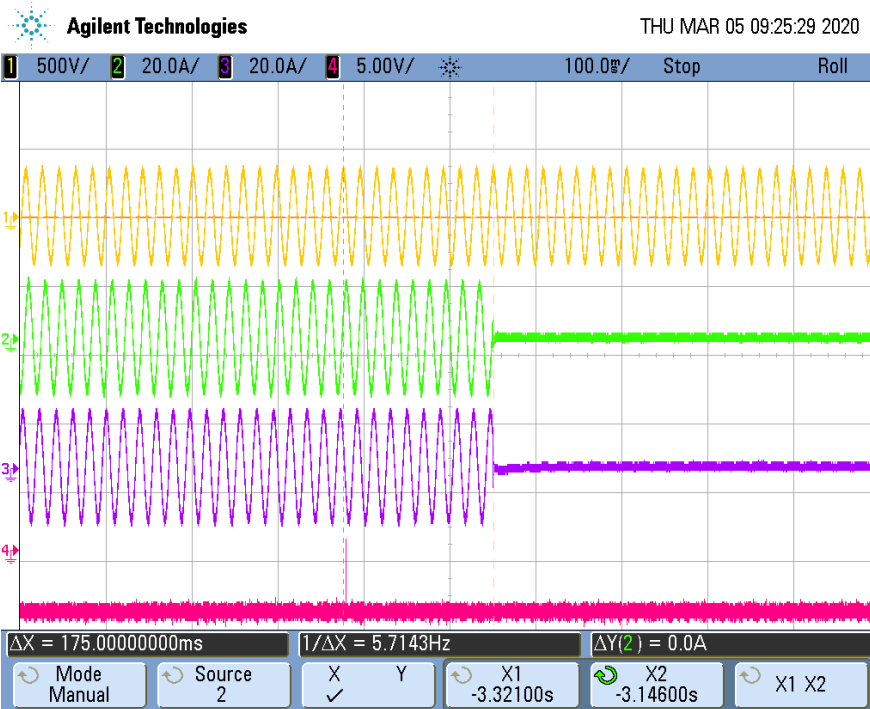

Frequency increase

CH1 denotes Voltage of output, CH2,CH3 denotes current of output, CH4 denotes trip signal.

6.5	TABLE: Monitoring the dc current	P
P = 0.25 P <sub>N</sub> (W)		3750W
Feed-in current = 1.0 A d.c., Cut-off current = (ms)		187.0
P = 0.5 P <sub>N</sub> (W)		7500W
Feed-in current = 1.0 A d.c., Cut-off current = (ms)		182.0
P = 1.0 P <sub>N</sub> (W)		15000W
Feed-in current = 1.0 A d.c., Cut-off current = (ms)		182.0



Feed-in current at 25%P

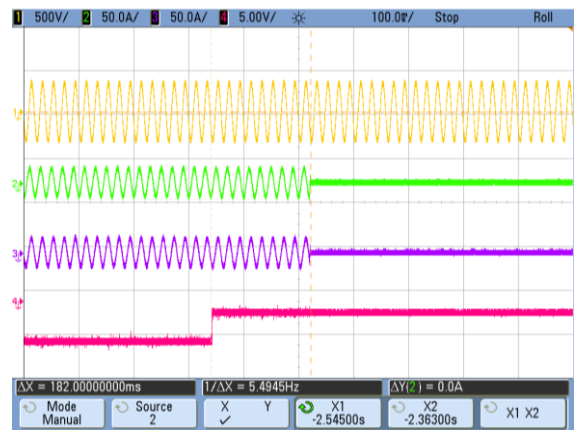

Feed-in current at 50%P

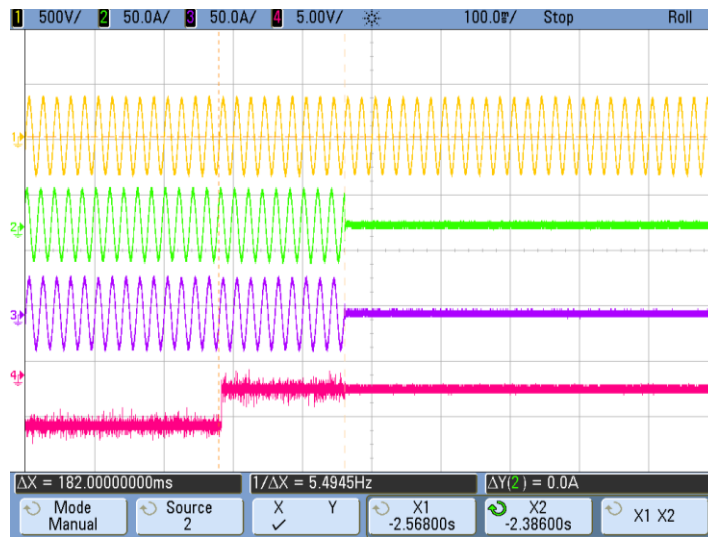

Feed-in current at 100%P

CH1 denotes Voltage of output, CH2 denotes current of output, Blue denotes trip signal.

6.6 (5.4.6)		TABLE: Detection of islanding operation				P
Test conditions:		Frequency: 50+/-0,2Hz UN=230+/-3Vac RLC consumes inverter real power within +/-3% Distortion factor of chokes <3% Quality Q>2				
P = 1.0 P <sub>N</sub> = (W)	15025W	P = 0.5 P <sub>N</sub> = (W)	7496W	P = 0.25 P <sub>N</sub> = (W)	3753W	
Q <sub>L</sub> = 31.61KVar	Cut-off time (ms)	Q <sub>L</sub> = 15.79KVar	Cut-off time (ms)	Q <sub>L</sub> = 7.88KVar	Cut-off time (ms)	
95%	142	95%	140	95%	146	
96%	262	96%	222	96%	212	
97%	156	97%	356	97%	170	
98%	154	98%	222	98%	146	
99%	156	99%	174	99%	132	
100%	318	100%	180	100%	166	
101%	310	101%	190	101%	112	
102%	160	102%	162	102%	128	
103%	140	103%	146	103%	166	
104%	138	104%	144	104%	122	
105%	137	105%	136	105%	118	

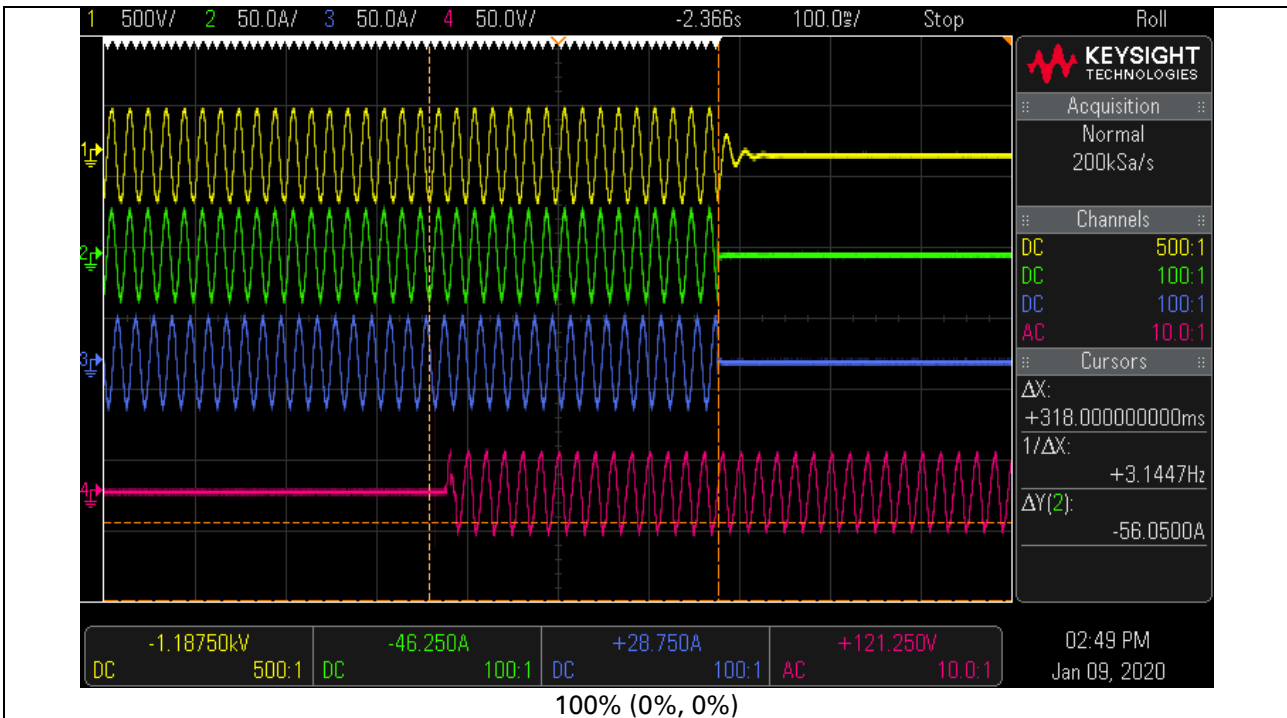

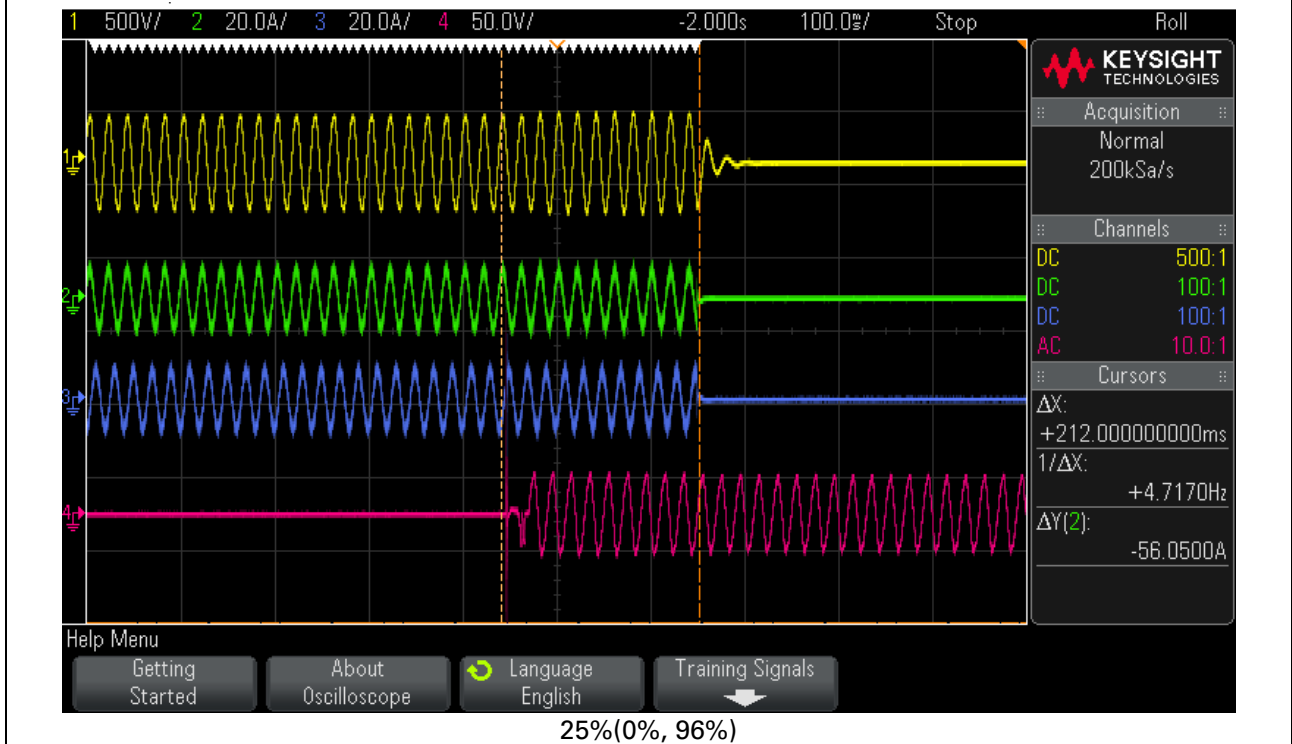
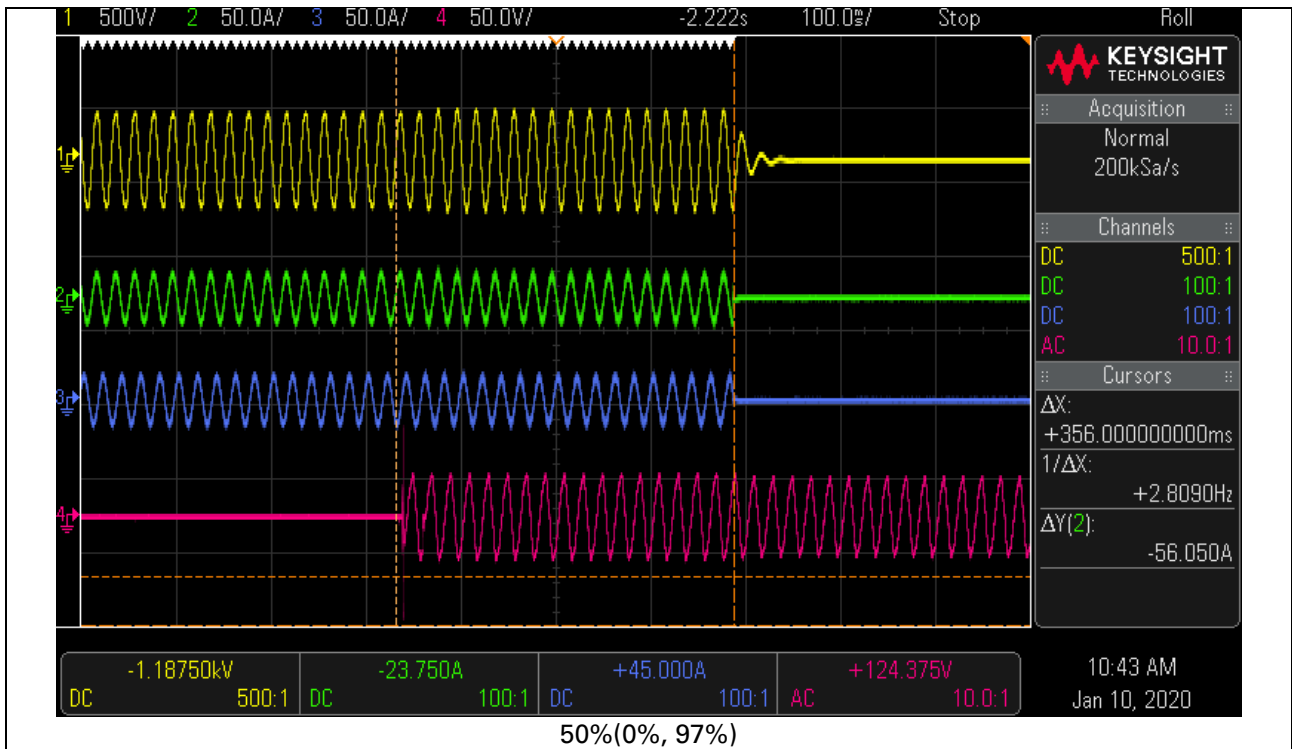



**Appendix Photos**



Front view

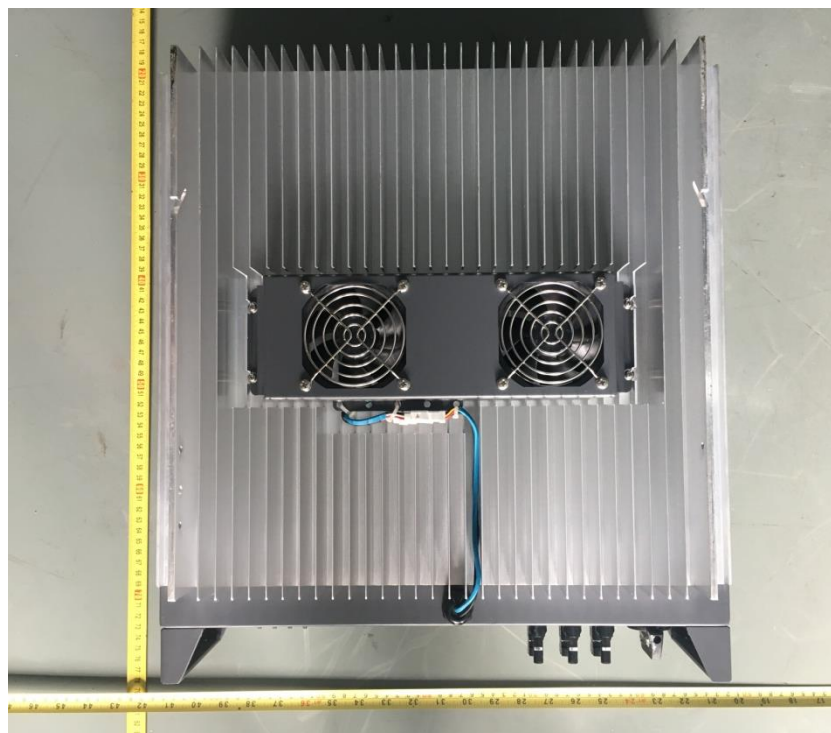

Rear view

**Appendix Photos**



Connection view



Internal view

**Appendix Photos**



Internal view (for model SOFAR 10000TL-G2, SOFAR 12000TL-G2)



Internal view (for model SOFAR 15000TL-G2)

--- End of test report---